

42" G71 Straight Grab Bar

Model #: **G71-42-**



FEATURES:

- ADA compliant when properly installed
- All brass construction, fully polished & plated
- All grab bars can be custom sized. Contact JACLO for pricing & availability
- Optional handshower sliders and toilet paper/wash cloth holders can be added only upon initial order
- Grab bars over 32" REQUIRE a middle post

AVAILABLE FINISHES:

| | | |
|-------------------------|---------------------|-----------------------|
| Polished Chrome (PCH) | Satin Chrome (SC) | Bronze Umber (BU) |
| Satin Nickel (SN) | Pewter (PEW) | Caramel Bronze (CB) |
| Polished Nickel (PN) | Antique Brass (AB) | Antique Copper (ACU) |
| Oil-Rubbed Bronze (ORB) | Polished Brass (PB) | Polished Copper (PCU) |
| Vintage Bronze (VB) | Satin Brass (SB) | Matte Black (MBK) |
| Satin Gold (SG) | Polished Gold (PG) | Black Nickel (BKN) |
| Bombay Gold (BG) | Jewelers Gold (JG) | Europa Bronze (EB) |
| White (WH) | Sedona Beige (SDB) | Tristan Brass (TB) |
| Unlacquered Brass (ULB) | Satin Cooper (SCU) | |

SPECIFICATION DRAWING:

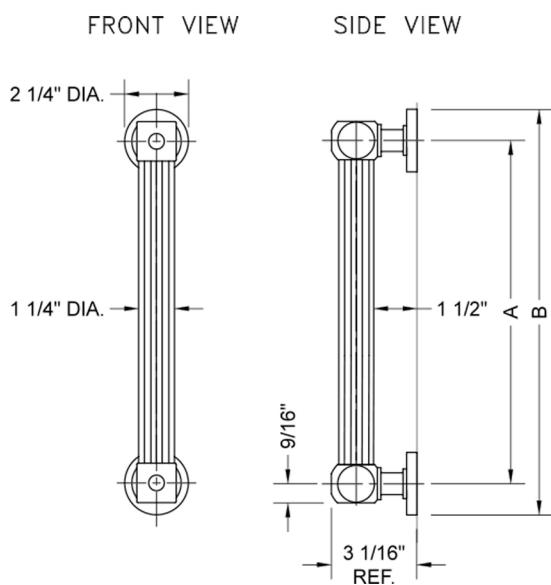

| BRASS LUXURY GRAB BARS | | | |
|--|--------------|-----|---------|
| PART. # | DESCRIPTION | A | B |
| G71-12-XX | 12" GRAB BAR | 12" | 14 1/4" |
| G71-16-XX | 16" GRAB BAR | 16" | 18 1/4" |
| G71-18-XX | 18" GRAB BAR | 18" | 20 1/4" |
| G71-24-XX | 24" GRAB BAR | 24" | 26 1/4" |
| G71-32-XX | 32" GRAB BAR | 32" | 34 1/4" |
| <i>*NOTE: GRAB BARS OVER 32" REQUIRE A MIDDLE POST</i> | | | |
| G71-36-XX | 36" GRAB BAR | 36" | 38 1/4" |
| G71-42-XX | 42" GRAB BAR | 42" | 44 1/4" |
| G71-48-XX | 48" GRAB BAR | 48" | 50 1/4" |
| G71-60-XX | 60" GRAB BAR | 60" | 62 1/4" |