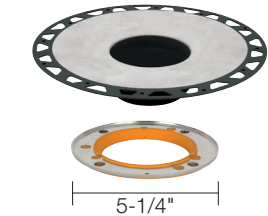

Product Item Numbers

Schluter®-KERDI-DRAIN-A

ADAPTOR KIT — 5-1/4" or 7-1/2" ADAPTOR RING

Schluter®-KERDI-DRAIN-A ADAPTOR KITS are used to convert traditional clamping ring drains to integrated bonding flange drains when removal of the clamping ring drain is not practical. A stainless steel adaptor ring with an overmolded rubber gasket replaces the clamping ring and is sealed to the existing drain body using Schluter®-KERDI-FIX. The bonding flange then slides into the adaptor ring and seals against the rubber gasket. Adaptor kits are suitable for both mortar bed and Schluter®-KERDI-SHOWER-T/-TS/-TT shower tray applications.

5-1/4" (133.4 mm) adaptor ring	
Flange and ring	Item No.
 <p>Also included: Height adjustment collar for KERDI-DRAIN grate</p>	KDA5 FLK ABS

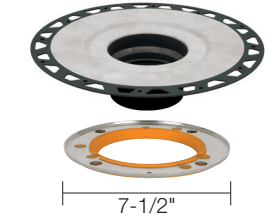
7-1/2" (191 mm) adaptor ring	
Flange and ring	Item No.
 <p>Also included: Lateral adjustment ring for KERDI-DRAIN grate</p>	KDA7 FLK ABS

Additional components included

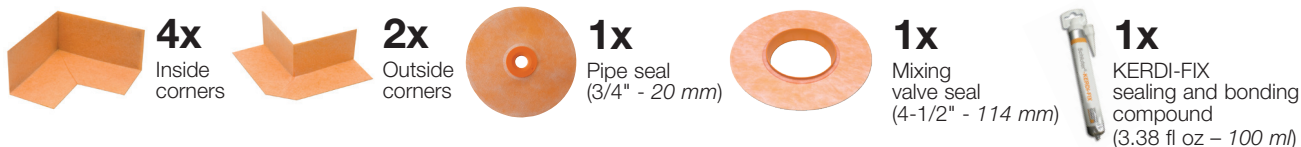

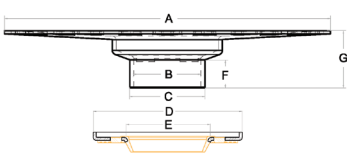
Flange and adaptor ring measurements		5-1/4"	
	A	11-13/16"	- 300 mm
	B	2-13/32"	- 60.7 mm
	C	2-23/32"	- 69.3 mm
	D	5-1/4"	- 133.4 mm
	E	2-29/32"	- 74 mm
	F	1-1/64"	- 25.9 mm
	G	2-1/16"	- 52.6 mm

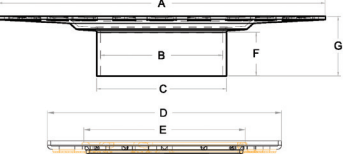
Flange and adaptor ring measurements		7-1/2"	
	A	11-13/16"	- 300 mm
	B	4-13/32"	- 111.8 mm
	C	4-11/16"	- 118.9 mm
	D	7-1/2"	- 191 mm
	E	5-7/64"	- 130 mm
	F	3-1/16"	- 77.8 mm
	G	3-41/64"	- 92.4 mm



The TILE grate and the 6" round/square grates and clean out cover are not compatible with the 5-1/4" ring flange.

Schluter®-KERDI-DRAIN-F

FLOOR DRAIN WITH INTEGRATED KERDI COLLAR

Schluter®-KERDI-DRAIN-F is a floor drain specifically designed to allow connections to Schluter®-DITRA and DITRA-HEAT uncoupling membranes in floor applications. The drain body is available in polypropylene or stainless steel, each with a laminated Schluter®-KERDI collar that ensures a simple connection to the uncoupling membrane on the floor and at wall transitions. KERDI-DRAIN-F features a flat, narrow bonding flange to allow for placement against walls or in corners on floors. It can be combined with virtually any KERDI-DRAIN grate assembly, with the exception of the tileable grate and the 6" (150 mm) square and round grates. The grate assembly is sold separately.



Schluter®-KERDI-DRAIN-F - Floor drain with narrow bonding flange and integrated KERDI collar

Polypropylene

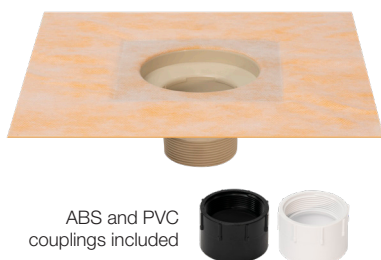

ABS and PVC couplings included

Stainless steel with no-hub outlet



Stainless steel with threaded outlet

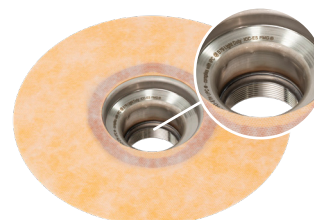

Material	Outlet	Item No.
Polypropylene	50 mm - 2" NPT	KDF2FL
Stainless Steel	50 mm - 2" no-hub	KDF2EFL
Stainless Steel	50 mm - 2" threaded	KDF2ETHFL

Listed by ICC-ES (Report No. PMG-1204), UPC® and CSA.

Additional components included



1x

Vertical height adjustment collar



1x

Construction cover

i

The TILE grate and the 6" (150 mm) round/square grates and clean out cover are not compatible with KERDI-DRAIN-F.

Drain measurements

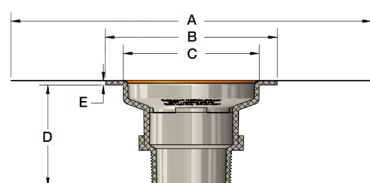

Polypropylene 50 mm (2") outlet

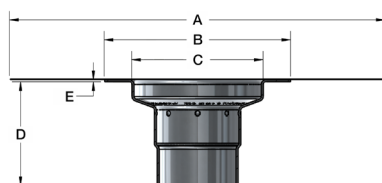

Stainless steel 50 mm (2") no-hub outlet

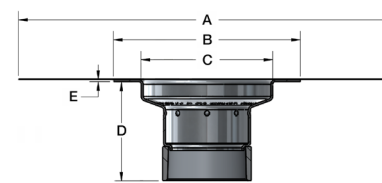

Stainless steel 50 mm (2") threaded outlet

A	268 mm - 10-9/16"
B	128 mm - 5-1/32"
C	101.1 mm - 3-31/32"
D	75.4 mm - 2-31/32"
E	3 mm - 1/8"

A	280 mm - 11-1/32"
B	139 mm - 5-15/32"
C	98 mm - 3-27/32"
D	77.2 mm - 3-1/32"
E	1.5 mm - 1/16"

A	280 mm - 11-1/32"
B	139 mm - 5-15/32"
C	98 mm - 3-27/32"
D	73.7 mm - 2-29/32"
E	1.5 mm - 1/16"

Schluter®-KERDI-DRAIN

4" (100 mm) GRATES

Schluter®-KERDI-DRAIN-STYLE

PURE



Brushed stainless steel	Brushed nickel	Brushed rose gold	Brushed vintage gold	Brushed classic gold
Item No.	Item No.	Item No.	Item No.	Item No.
KDIF4 GRK EB D8	KDIF4 GRK EBT D8	KDIF4 GRK EBRG D8	KDIF4 GRK EBVG D8	KDIF4 GRK EBCG D8



Cream	Greige	Stone grey	Bronze	Matte white	Matte black
Item No.	Item No.	Item No.	Item No.	Item No.	Item No.
KDIF4 GRK TSC D8	KDIF4 GRK TSBG D8	KDIF4 GRK TSSG D8	KDIF4 GRK TSOB D8	KDIF4 GRK MBW D8	KDIF4 GRK MGS D8

CURVE



Brushed stainless steel	Brushed nickel	Brushed rose gold	Brushed vintage gold	Brushed classic gold
Item No.	Item No.	Item No.	Item No.	Item No.
KDIF4 GRK EB D6	KDIF4 GRK EBT D6	KDIF4 GRK EBRG D6	KDIF4 GRK EBVG D6	KDIF4 GRK EBCG D6



Cream	Greige	Stone grey	Bronze	Matte white	Matte black
Item No.	Item No.	Item No.	Item No.	Item No.	Item No.
KDIF4 GRK TSC D6	KDIF4 GRK TSBG D6	KDIF4 GRK TSSG D6	KDIF4 GRK TSOB D6	KDIF4 GRK MBW D6	KDIF4 GRK MGS D6

FLORAL



Brushed stainless steel	Brushed nickel	Brushed rose gold	Brushed vintage gold	Brushed classic gold
Item No.	Item No.	Item No.	Item No.	Item No.
KDIF4 GRK EBD5	KDIF4 GRK EBT D5	KDIF4 GRK EBRG D5	KDIF4 GRK EBVG D5	KDIF4 GRK EBCG D5



Cream	Greige	Stone grey	Bronze	Matte white	Matte black
Item No.	Item No.	Item No.	Item No.	Item No.	Item No.
KDIF4 GRK TSC D5	KDIF4 GRK TSBG D5	KDIF4 GRK TSSG D5	KDIF4 GRK TSOB D5	KDIF4 GRK MBW D5	KDIF4 GRK MGS D5

Stainless steel - CLASSIC



Stainless steel

Item No.

KD4 GRK E



Chrome

Item No.

KD4 GRK EP



Oil-rubbed bronze

Item No.

KD4 GRK EOB



Nickel

Item No.

KD4 GRK ET

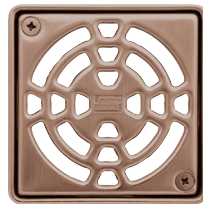

Rose gold

Item No.

KD4 GRK ERG

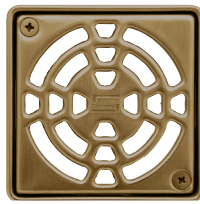

Vintage gold

Item No.

KD4 GRK EVG

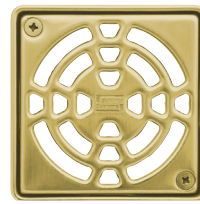

Classic gold

Item No.

KD4 GRK ECG

Anodized aluminum - CONTOUR



Brushed nickel anodized aluminum

Item No.

KD4 GRK ATGB



Brushed copper anodized aluminum

Item No.

KD4 GRK AKGB



Brushed brass anodized aluminum

Item No.

KD4 GRK AMGB

Contents



1x

Grate and frame



1x

Height adjustment collar



1x

Lateral adjustment ring

Schluter®-KERDI-DRAIN

4" (100 mm) GRATES

TILE

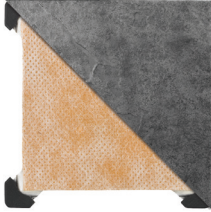

Tileable covering support
Item No.
KD4 GRK ECS



The TILE grate is not compatible with KERDI-DRAIN-F and KERDI-DRAIN-A with 5-1/4" adaptor ring.

Contents

 <p>1x Tileable covering support</p>	 <p>1x Spacer</p>	 <p>1x Lateral adjustment ring</p>
---	--	---

6" (150 mm) GRATES

Stainless steel - CLASSIC



Stainless steel - 6" square
Item No.
KD6 GRK E





Stainless steel - 6" round
Item No.
KD6 GRK RE









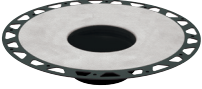

The 6" square and round grates are not compatible with KERDI-DRAIN-F and KERDI-DRAIN-A with 5-1/4" adaptor ring.

Contents

 <p>1x Grate and frame with integrated height adjustment collar</p>	 <p>1x Lateral adjustment ring</p>
---	--

ADAPTOR KIT — 5-1/4" ADAPTOR RING - 4" STAINLESS STEEL GRATE



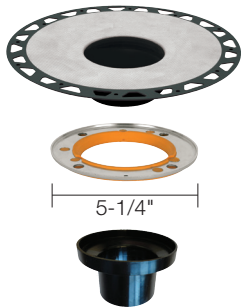

5-1/4" (133.4 mm) adaptor ring	
4" (100 mm) square grate	
Stainless steel	KDAR/ABS/E

Contents	
	1x Flange
	1x Grate and frame
	1x Height adjustment collar
	1x Adaptor ring
	4x Inside corners
	2x Outside corners
	1x Pipe seal (3/4" - 20 mm)
	1x Mixing valve seal (4-1/2" - 114 mm)
	1x KERDI-FIX sealing and bonding compound (3.38 fl oz - 100 ml)

10 PACKS — ADAPTOR KIT - 5-1/4" ADAPTOR RING

5-1/4" (133.4 mm) adaptor ring	
Flange and ring	Item No.
 <p>5-1/4"</p> <p>Also included: Height adjustment collar for KERDI-DRAIN grate</p>	KDA5 FLK ABS 10

Additional components included

	40x Inside corners		20x Outside corners
	10x Pipe seal (3/4" - 20 mm)		10x Mixing valve seal (4-1/2" - 114 mm)
	10x KERDI-FIX sealing and bonding compound (3.38 fl oz - 100 ml)		

Note: 10 packs are packaged in bulk, not individually boxed.



The TILE grate and the 6" round/square grates and clean out cover are not compatible with the 5-1/4" ring flange.



10 PACKS — 4" GRATE - STAINLESS STEEL

Stainless steel - CLASSIC



Stainless steel
Item No.
KD4 GRK E 10

Note: 10 packs are packaged in bulk, not individually boxed.

Contents			
	10x Grate and frame		10x Height adjustment collar
	10x Lateral adjustment ring		

Schluter®-KERDI-DRAIN

6" SQUARE CLEAN OUT COVER

The **Schluter®-KERDI-DRAIN Clean Out Cover** is a 6" stainless steel cover available for installations where the KERDI-DRAIN bonding flange is to be used in a cleanout application.



The clean out cover is not compatible with KERDI-DRAIN-F and KERDI-DRAIN-A with 5-1/4" ring flange.



Clean out cover 6"	
Item No.	Finish
KD-GR6C-E	Stainless steel

TAMPER PROOF SCREWS

Schluter®-KERDI-DRAIN Tamper Proof Screws are designed as a high security accessory for the KERDI-DRAIN. Ideal for loss prevention and anti-theft, these tamper proof screws are used in environments where tamper resistance is desired or required (e.g., healthcare or education facilities, etc.). Phillips head screws are included with the KERDI-DRAIN. The tamper-proof screws as well as the driver bit must be purchased separately.



Tamper proof screw and driver bit	
Item No.	Description
KD/TPSCRW	Tamper proof screw
KD/TPWRCH	Driver bit