

Silhouette - 30"

Specification & Installation Guide

Features

- Free Standing 30" vanity: 33" (838mm)H x 22"(558mm)D x 29-5/8" (753mm)W
- Furniture grade plywood layered with solid wood veneer and protected with several coats of polyurethane.
- Matching finish inside out
- Two drawers with full-extension soft-close hardware.
- Drawers include adjustable tempered glass dividers.
- Tempered soft-frost glass shelf.
- Handle and legs in Polished Chrome (PC), Brushed Nickel (BN), Polished Nickel (PN), Matte Black (MB) and Satin Brass (SB) finishes.
- Ships fully assembled except for tempered glass shelf.

Colors/Finishes

- Ash Grey (AG)
- Brandy (BR)
- Glossy White (GW)
- Sapphire (SA)

Top/Basin options

- Tempered glass countertop /Ceramic basin
- Glossy White X-Stone 2"H top/basin
- Glossy White X-Stone 4-1/2" H Trough sink
- Glossy or Matte White X-Stone countertop/no holes
- Glossy or Matte White X-Stone countertop/Ceramic basin
- Quartzstone™ 3"H countertop/under mount ceramic basin

Package Dimensions

25" x 33" x 35"

Weight

120 lbs/55 kgs.

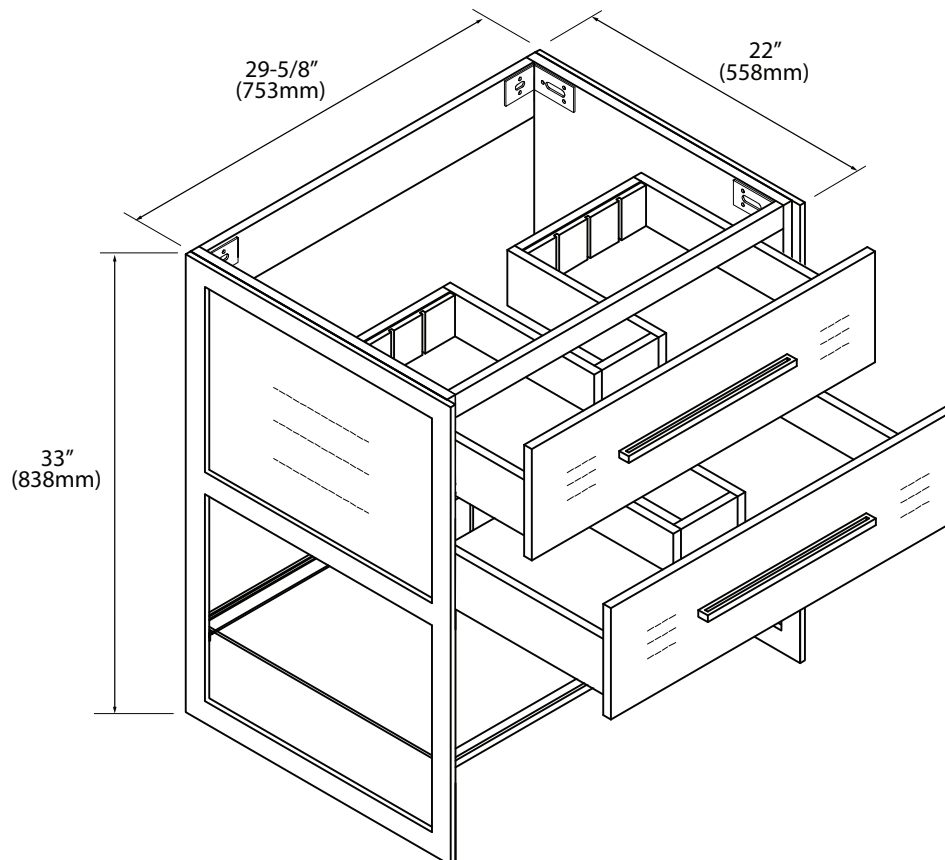

Silhouette - 30"

Specification & Installation Guide

FRONT VIEW

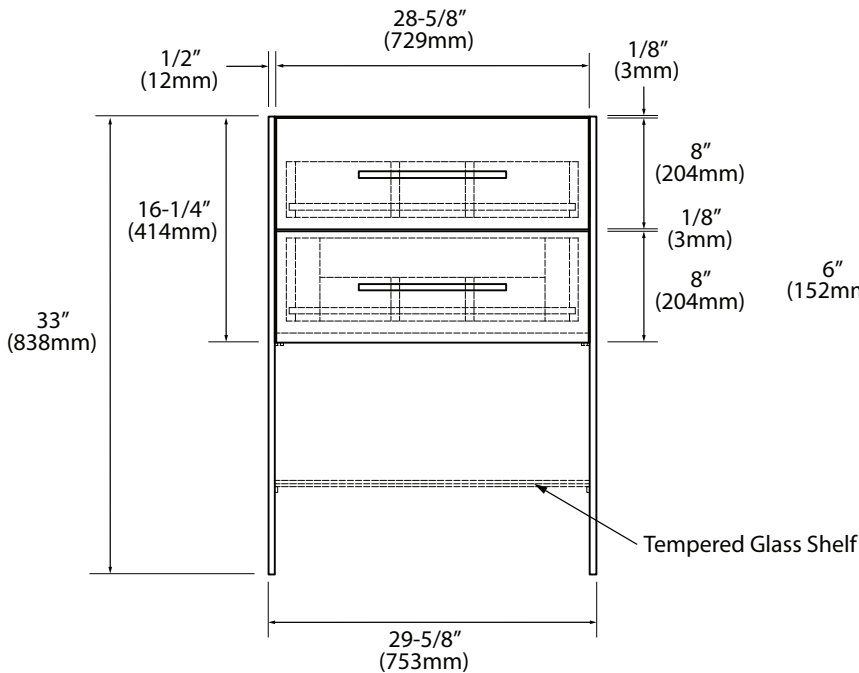

SIDE VIEW

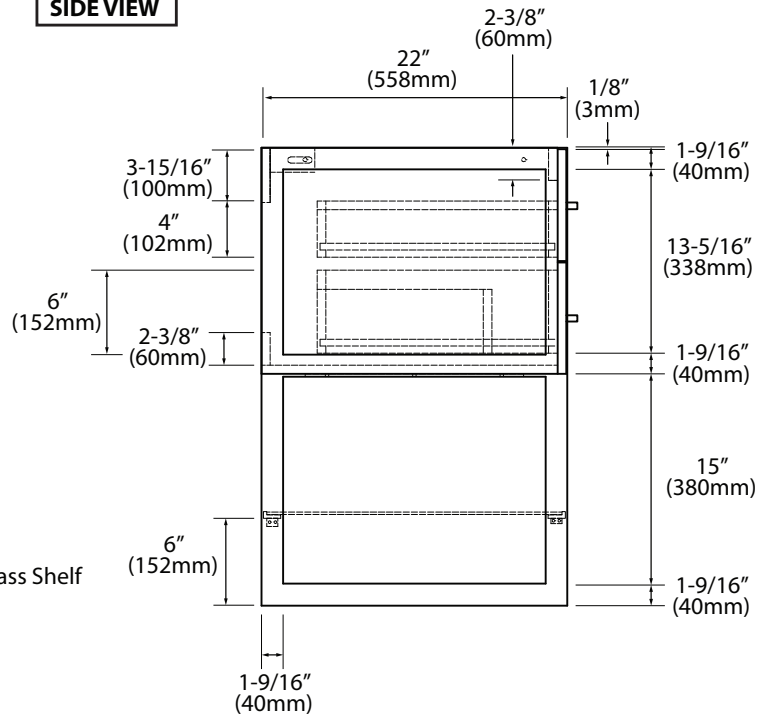

TOP VIEW

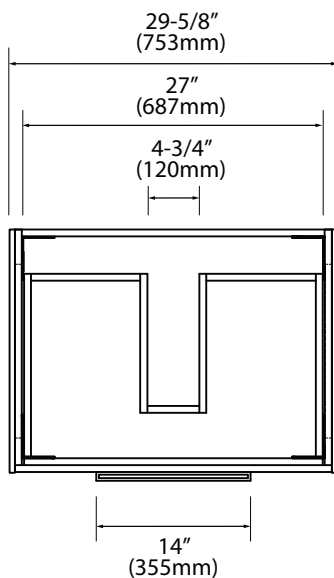

ROUGH-IN DIMENSIONS

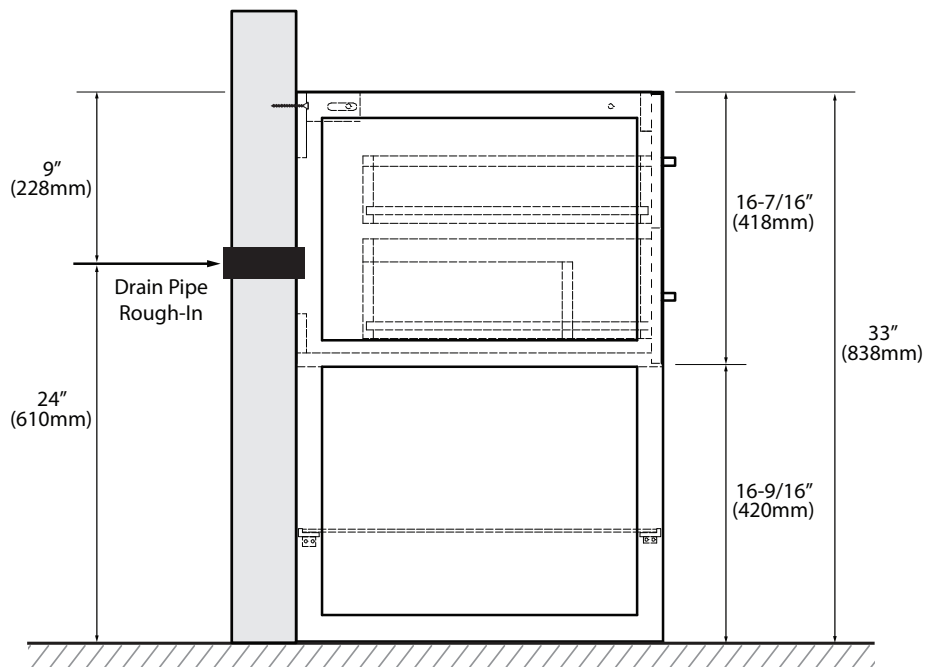

Silhouette - 30"

Specification & Installation Guide

CABINET PLACEMENT & INSTALLATION - CABINET MUST BE SECURED TO WALL

- 1) Place cabinet in position
- 2) Level cabinet (shim as needed)
- 3) Secure cabinet with screws in drywall studs
- 4) Install countertop with silicone
- 5) Install tempered glass shelf

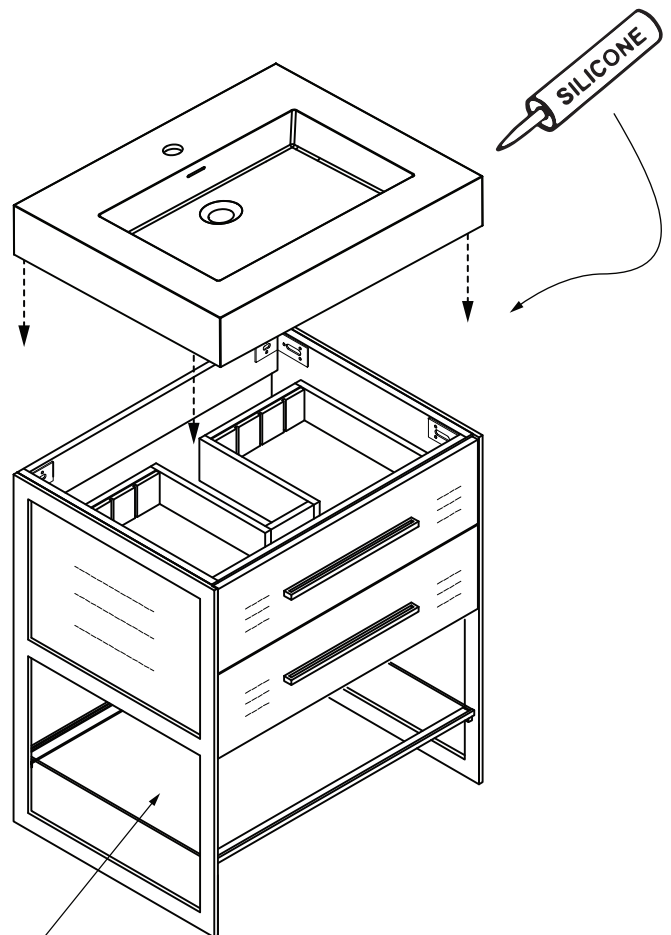
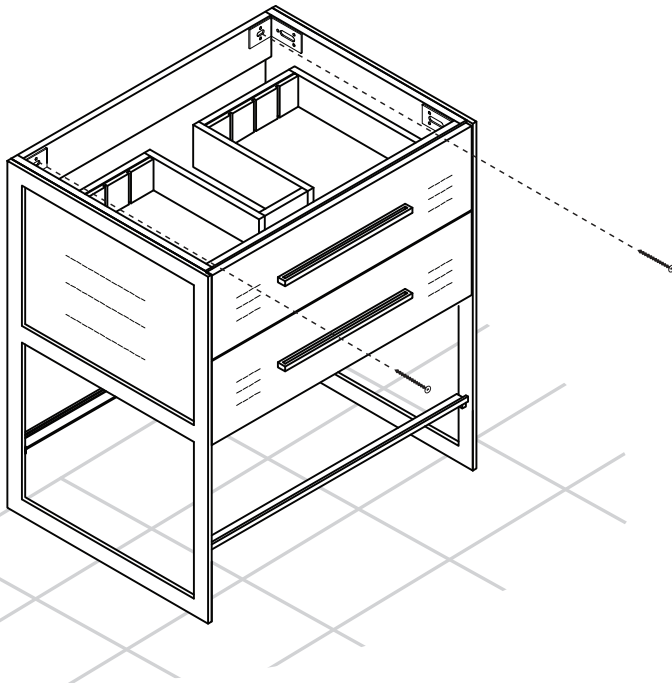

Install tempered glass shelf

For clarification, please contact Madeli Customer Care at (800)-819-6988 or (305)-718-8817 Ext. 1 or service@madeli.com
All dimensions are approximate and subject to standard tolerance. Specifications subject to change without prior notice.