

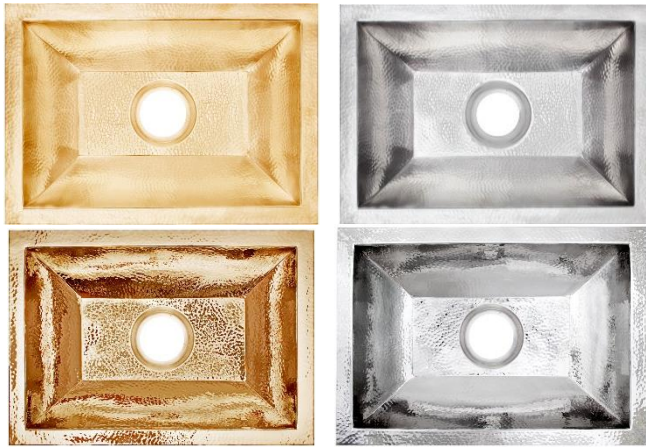

Shown in SS



BLD107-3.5

COCO HAMMERED BUILDER'S SERIES

DETAILS

Materials: Copper, Brass, or Stainless Steel





Installation Type: Drop-In or Undermount

3.5" Drain Opening, No Overflow





Each sink is hand-crafted; no two sinks will be the same

NOTE: Due to the handmade nature of the sink, dimensions are approximate and variations in the metal may be visible.

AVAILABLE FINISHES

	SS	Satin Stainless Steel
	PS	Polished Stainless Steel
	UB	Satin Unlacquered Brass
	PB	Polished Unlacquered Brass

AVAILABLE DRAINS

	D003	Basket Strainer
	D007	Disposal Flange
	D051-D057	Decorative Basket Strainer
	D071-D077	Disposal Flange with Decorative Basket

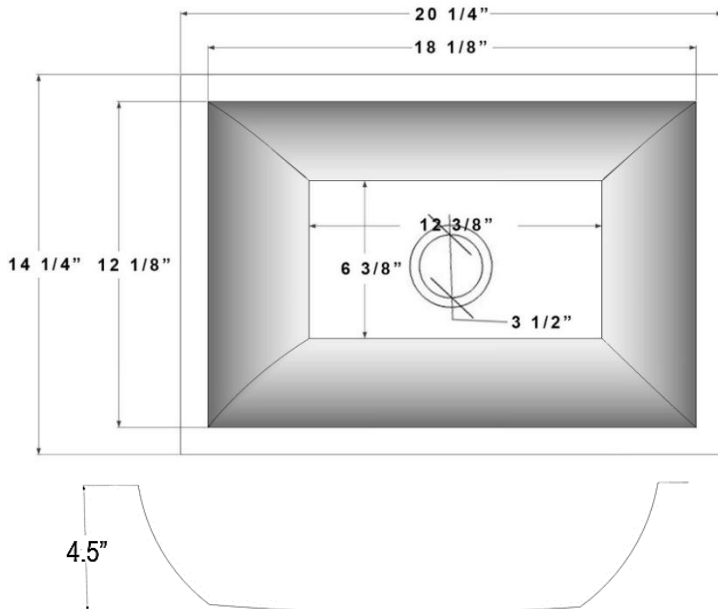

INSTALLATION

Drain should be installed first.

DROP-IN: Cut opening large enough for the sink to be "dropped in" to countertop. **UNDERMOUNT:** Use actual sink for templating. Cuts in countertop are up to the discretion of the installer. Clips or other installation method must be provided by the fabricator/installer. Use silicone adhesive to adhere sink to countertop. Clean any excess silicone from sink surface to avoid damaging the finish.

CARE

This sink has a living finish (excluding SS/PS), which will change with time and use. Use mild soap and water for everyday cleaning. Avoid any harsh abrasives, acidic cleaning products, and antibacterial hand soap. A paste wax may be applied periodically to protect the finish and help with water spotting.

WARRANTY

Linkasink warranties our product to be free from manufacturing defect for the life of the product. Warranty does not cover improper care or abuse/neglect, or changes to the living finish.

DIMENSIONS WILL VARY

DO NOT use this sheet as a guide for countertop cuts. Due to the handmade nature of each product, templates are not provided.

P: 602.971.2502

E: sales@linkasink.com

Linkasink may make changes to specifications without notice.

Visit linkasink.com for updated specification sheet.

3/21/2023